

Type 31 med 48x71mm trerekker

Himling: stålplate med 50mm Rockwool tungplate

U-verdi: 0,14 W/m²K

Brannklasse REI 60

Detalj ved opplegg

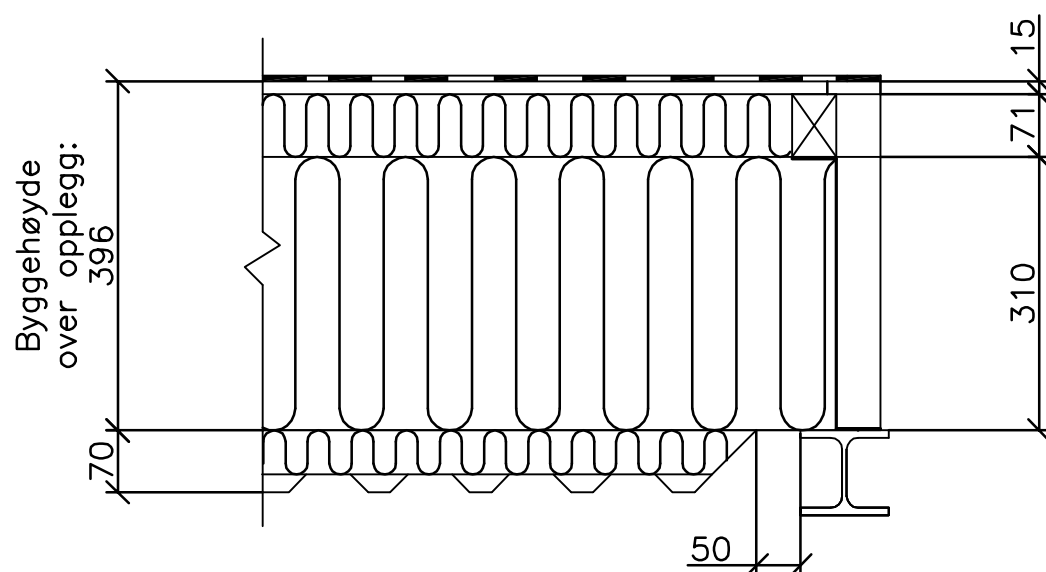

Detalj ved randdrager

