

Type 36 med 48x121mm trerekker

Himling: stålplate med 70 mm Rockwool tungplate

U-verdi: 0,10 W/m²K

Brannklasse REI 60

Detalj ved opplegg

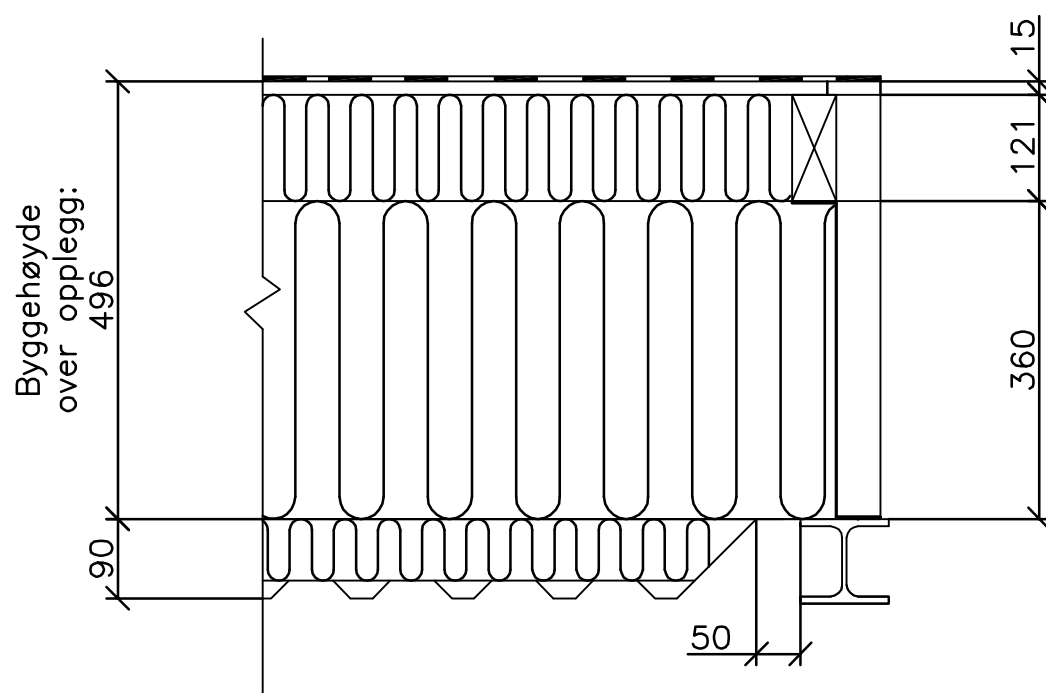

Detalj ved randdrager

