

Type 36 med 48x96mm trerekker

Himling: stålplate med 50mm Rockwool tungplate

U-verdi: 0,12 W/m²K

Brannklasse REI 60

Detalj ved opplegg

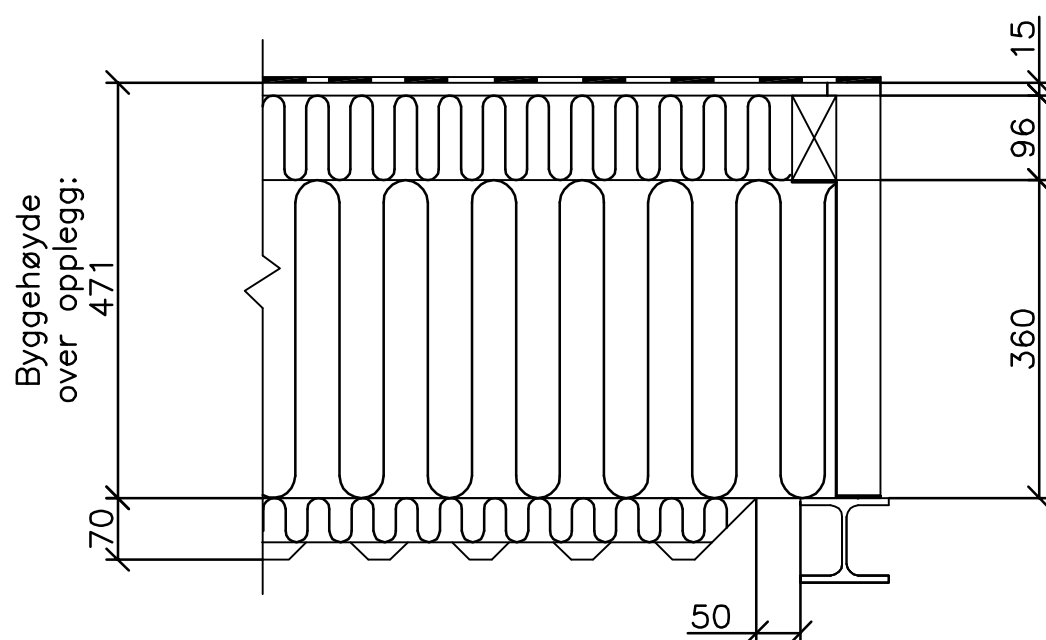

Detalj ved randdrager

